

# EMMA

## 6642

**SIZE**

66" L x 42"W x 22"D

**WATER CAPACITY**

85 Gallons

**WEIGHT**

95-135 Pounds

**INSTALLATION**

Drop-in

**BACK SLOPE**

22°

**MATERIAL**

Acrylic

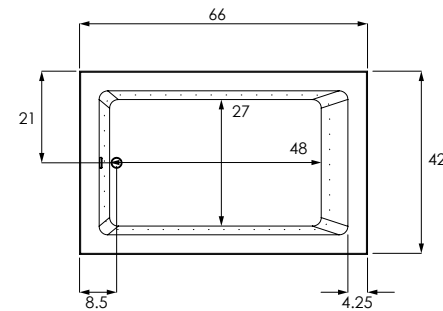
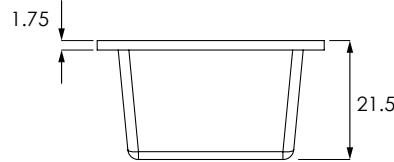
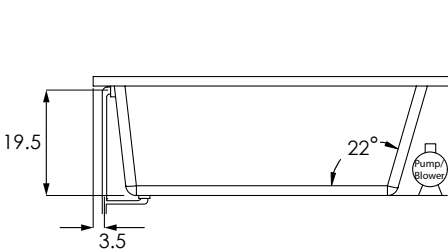

MODEL	
EMM6642ATO	Tub Only
EMM6642AWP	Whirlpool (8)
EMM6642ATA	Thermal Air
EMM6642ACO	Combo System
COLORS	
Standard	White   Biscuit   Bone
Premium Colors	Black   Sterling Silver
FINISH	
Matte Finish	MAT (must specify if desired)
Polished Finish	STANDARD
BACK MASSEUSE SYSTEMS	
System I - Manual Control (WP/CO)	BAC.MA1-XXX
System II - Electronic Control (WP/CO)	BAC.MA2-XXX
System III - Electronic Control (TA)	BAC.MA3-XXX
COLD PLUNGE   <a href="#">order form</a>	
	CLD.PL
EXPORT CRATE	
	FRT.EXPCRT
EXTRA HIGH DENSITY	
	HI.DEN
GRAB BARS (Pair) Refer to price book for all available finishes	
Standard Grab Bars	GRA.BAR-XXX
Universal Grab Bars	UGB.BAR-XXX

MODEL	
<b>HEATED BACKREST</b>	INCLUDED ON THERMAL AIR
<b>HYDRO BLANKET</b> 2 Zones   3 Zones   4 Zones   5 Zones (3 or 4 zones require two keypads. 5 zones require 3 keypads)	BLA.HEA-X
<b>HYDRO COAT</b>	HYC.COA
<b>HYDRO EXPRESS</b>	69.104-HYD.EXP
<b>HYDRO FILL</b> (must specify location)	HYD.FIL
<b>HYDRO FUSION</b>	
Hydro Fusion (Tub Only)	29.102
Hydro Fusion w/ Ozone (Tub Only)	29.103
Hydro Fusion (TA, Whirlpool, Combo)	29.107
<b>HYDRO INDULGE</b>	HYD.IND
<b>HYDRO OZONE UV COMBO SYSTEM</b> Whirlpool and Combo Systems only	OZUV.XXX 110 V   OZUV.110
<b>INLINE HEATER</b> Whirlpool and Combo Systems only No dedicated GFI required for 6 amp models	
12.50 Amps 1.5 KW - 110V	27.100
6.00 Amps 0.75 KW	27.103



**Headquarters**  
29132 Avenue Paine  
Valencia, CA 91355

**Manufacturing Facility**  
385 Highway 155 South  
McDonough, GA 30253

**Technical Support**  
support@hydrosystem.com

**Orders Department**  
orders@hydrosystem.com

**General Information**  
info@hydrosystem.com  
**Phone:** 661-775-0686  
**Website:** hydrosystem.com

**CODES AND COMPLIANCES**

Massachusetts code File no: P1-0614-491



All specifications and options subject to change without notice please contact a hydro systems representative for more information.

# EMMA

## 6642

**DESCRIPTION**

**JETS**  
Installed per jet price for extra jets added to standard system price. All metallic finishes come with colored eyeball.

**Additional Standard or Swirling Jet** JET.STD-XX | JET.SWI-XX  
Color Trim  
Group 1 - PC or PB  
Group 2 - AB, BB, SB, BC, SC, PN, SN, BN  
Group 3 - PG, BG, SG

**Swirling Jet Upgrade** JUP.SWI-XX  
(Per jet substitution price added to standard system price)

**Micro Therapy Jet** MTJ.XXX  
BIS, BLA, BON, SIL, WHI

**Custom Jet Locations** 69.116-CUS.JET  
(Must include drawing of locations)

**JET PLATING**  
Clear / Brass / Chrome. Trim kit covers jet escutcheons, suction, and electronic softtouch pad. Per jet substitution price added to standard system price. All metallic finishes come with colored eyeball.

**Group 1 (PC or PB)**  
6 Jets PLA.06-XX  
8 Jets PLA.08-XX  
10 Jets PLA.10-XX

**Group 2 (AB, BB,SB, BC,SC,PN,SN,BN)**  
6 Jets PLA.06-XX  
8 Jets PLA.08-XX  
10 Jets PLA.10-XX

**Group 2 (PG, BG)**  
6 Jets PLA.06-XX  
8 Jets PLA.08-XX  
10 Jets PLA.10-XX

**LED TEMP. READOUT KEYPAD** LED.UPG  
Upgrade only, must have a keypad controlled system to purchase.

**LIGHTING** LIG.LED  
LED Bath Light Chromotherapy System

**LOW WATER PROTECTION** LOW.WAT-110  
Includes 30 minute timer (110V)

**MOLDED ARMRESTS** ARM.MOL-2  
Some molded armrests add an interior detail line to the bathtub 2 Armrests (one pair)

**DESCRIPTION**

**PADDED HEADREST PILLOW** 41.128  
Black only

**PUMPS** 69.116-CUS.PMP  
Custom Pump Locations

**REMOTE CONTROL** REM.CON  
Must must have system to purchase

**SKIRTS**  
**Integral Skirt**  
No access panel on Tub Only models.  
Gel Coat SKI.XXG-XXX  
Acrylic (Standard Colors) SKI.XXA-XXX  
Acrylic (Premium Colors) SKI.XXA-XXX

**Molded Skirt Panels**  
Additional lead time required; check with factory. Make sure to order a molded flange, if necessary.  
Seamed  
1 sided\* See Zen Skirt  
2 sided\* SKI.SMD-2  
3 sided\* SKI.SMD-3  
4 sided\* SKI.SMD-4

Seamless  
1 sided\* SKI.SML-1  
2 sided\* SKI.SML-2  
3 sided\* SKI.SML-3  
4 sided\* SKI.SML-4  
\*Specify which sides on worksheet.

**Floating Skirt** SKI.FLO-SML1  
Option for seamless skirt only SKI.FLO-SML2  
SKI.FLO-SMLX

**Zen Skirt** SKI.ZEN-XX  
Factory installed. No access panel.

**WASTE & OVERFLOW** WOV.XX  
Cable W/O No Charge  
(WHI, BIS, PC, PB, PN, BC, BB, BN, SC, SB, SN, ORB, PE, MB)

Cable W/O - Gold Finish Upgrade (PG, BG)

**INTEGRAL W/O (Std. round)** IWO.XX  
Waste and overflow manufactured as part of the bath. Comes standard as a round overflow cover. Drain will be a tip-toe style and drain outlet will be a direct drain.

**LINEAR INTEGRAL W/O** LWO-XXX  
Waste and overflow manufactured as part of the bath. Drain will be a tip-toe style and drain outlet will be a direct drain.



**Headquarters**  
29132 Avenue Paine  
Valencia, CA 91355

**Manufacturing Facility**  
385 Highway 155 South  
McDonough, GA 30253

**Technical Support**  
support@hydrosystem.com

**Orders Department**  
orders@hydrosystem.com

**General Information**  
info@hydrosystem.com

**Phone:** 661-775-0686

**Website:** hydrosystem.com

**CODES AND COMPLIANCES**

Massachusetts code File no: P1-0614-491



All specifications and options subject to change without notice please contact a hydro systems representative for more information.

# EMMA

## 6642



### STANDARD ACRYLIC COLORS



WHITE BISCUIT BONE

### PREMIUM ACRYLIC COLORS



BLACK STERLING SILVER

### WELLNESS OPTIONS



**Cold Plunge**  
Revitalizing cold hydrotherapy into a traditional tub

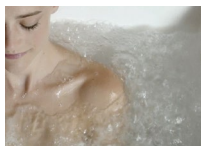

**Thermal Air**  
Tiny bubbles into the bathwater and offers untold relaxing benefits, similar to Swedish massage

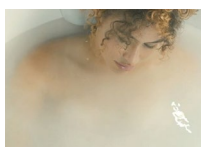

**Hydro Indulge**  
A concentrated dose of oxygen-rich molecules cleanse and restore skin



**Whirlpool Massaging Jets**  
Flexibility to customize jet location, quantity of jets and type of jet therapy



**Back and Neck Masseur**  
Utilizes six strategically located jets enabling a "shiatsu" type massage and direct to the neck with 3 pulse settings



**Advanced UV system**  
Ozone and UV light helps to disinfect the water and keep it clean

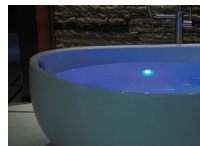

**Chromatherapy**  
Digitally controlled, multicolored lighting feature LED lighting system



**Hydro Fusion**  
Totally silent operation maintains ideal temperature without adding hot water constantly



**Hydro Blanket**  
Radiant heat emanates through the acrylic tub surface. Chose up to 2-5 panels.

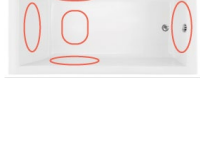

### Drop-In Cutout Install Dimensions:

- (L)ength - 64"
- (w)idth - 40"
- Finished Height - 20¾"

### OTHER OPTIONS

Additional options can be found on our website



**Integral Waste and Overflow**  
Seamless built-in protection for bathtub



**Grab Bars**  
Adds functionality and enhanced styling. Affords a mounting solution in virtually any position on any tub.



**Skirt**  
Add as many skirts to most rectangular drop-in tubs to fit any application. Seamed or seamless, peninsula, corner, freestanding

### Installation Tips:

- When adding integral linear drain p-trap location is now below waste
- Adding multiple systems/options may require equipment to stick out from tub deck or be installed remotely



HYDRO SYSTEMS



**Headquarters**  
29132 Avenue Paine  
Valencia, CA 91355

**Manufacturing Facility**  
385 Highway 155 South  
McDonough, GA 30253

**Technical Support**  
support@hydrosystem.com

**Orders Department**  
orders@hydrosystem.com

**General Information**  
info@hydrosystem.com

**Phone:** 661-775-0686  
**Website:** hydrosystem.com

### CODES AND COMPLIANCES

Massachusetts code File no: P1-0614-491



All specifications and options subject to change without notice please contact a hydro systems representative for more information.