

# Isabella

The Isabella is a tub that has it all: ample bathing space with arm rests, and soap dishes on both sides. Add to these features the gentle slope of the backrest and the Isabella has it all. 66" model shown, this model has a no-drip ledge.

### Available Sizes:

60"L x 36"W x 18¾"D  
 50 Gallons

66"L x 36"W x 19"D  
 60 Gallons

72"L x 36"W x 18¾"D  
 70 Gallons



### Acrylic Tub – construction features

**Acrylic** models finished in 1/8" thick layer of deep lustrous acrylic.

**Extra thick** reinforced fiberglass.

**Pre-wired** pump on pump platform (standard pump location only)

**Integral E-Z** Level platform facilitates installation.

**Non-skid** bottom.

### PVC Systems – include:

**6 Fully** directional adjustable PVC jets

**Anti-vortex** safety suction.

*Color matched* system trim

**Hydrozone** ozone sanitation system

**Rigid PVC** piping

**Self draining** pump and system

**Soft Touch** electronic on/off control with 30-min. integral timer

**2.25 HP** Single Speed Pump

**Cable** waste & overflow

### Hydro Systems – Options:

**Available** as Tub only, Thermal Air, Whirlpool or Combo

**Microban** Antibacterial Protection

**Extra High Density** Fiberglass

**Flange** molded

**Skirt**

**Custom** jet and pump locations

**Plated** Metallic finish

**Additional** directional Jets

**Swirling**, Rotating, or Jumbo Jets

**Micro Therapy** Jet

**Integral** Waste & Overflow

**1.5 HP** Variable Speed Pump (digital temperature display optional)

**Electronic** low water protection

**In-line** Heater

**Chromatherapy-LED** Lighting System

**Chromatherapy-LED** Mini Spotlights

**Mood Light**

**Grab Bars**

**Back Masseuse**

**Neck Masseuse Pillow**

**Hydro Fragrance**

**Hydro Fusion**

**Hydro Coat**

**Hydro Express quick ship**

### Approvals & Listings

Commonwealth of Massachusetts  
 UPC & USPC - US & Canada







# Isabella

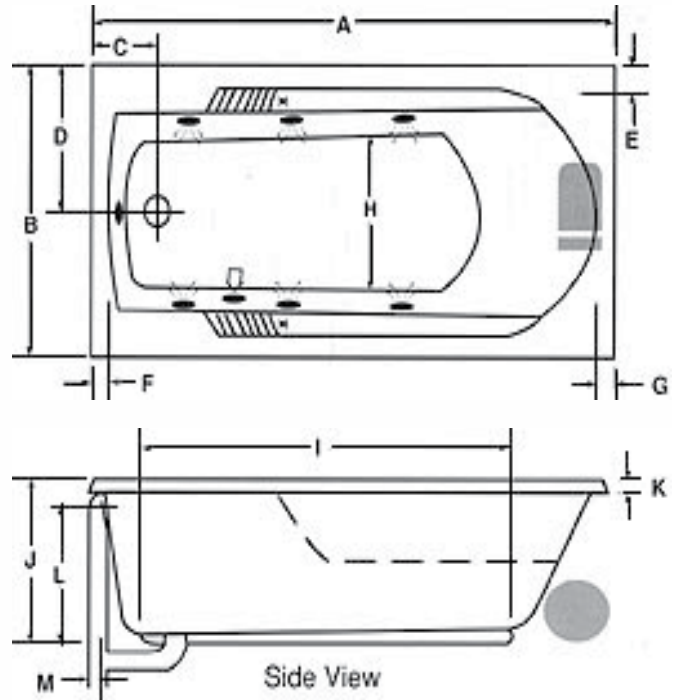

Must be set in Mortar Base



-  Pump motor
-  Jets
-  Anti-vortex suction
-  Overflow location

AS SHOWN:  
Whirlpool option w/ standard jets

ALSO AVAILABLE:  
Soaking Tub Only,  
Thermal Air, Combo

Side View

Model	GC	AC	A	B	C	D	E	F	G	H	I	J	K	L	M	Jet	Pump	Wat.Cap.
6036	N/A		59¾"	35¾"	8¼"	18"	2½"	2¼"	2¼"	22"	41½"	18¾"	1¾"	16¼"	1½"	6	2.25	50 gal.
6636	N/A		65¾"	35¾"	8½"	18"	2½"	2¼"	2¼"	22"	47½"	19"	1¾"	16½"	1½"	6	2.25	60 gal.
7236	N/A		71¾"	35¾"	8½"	18"	2½"	2¼"	2¼"	22"	53½"	18¾"	1¾"	16¼"	1½"	6	2.25	70 gal.
Amp	Volt	Breaker	Dedicated Service															
13.5	120	20 amp	GFCI Protected															

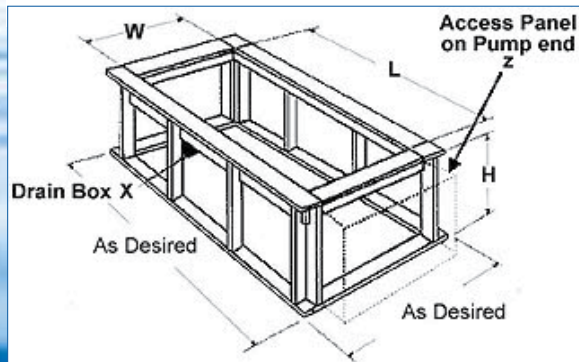

options or altering the pump/blower location may cause the pump/blower to extend beyond the tub decking. For cutout dimensions wait for unit to arrive. All specifications subject to change without notice.

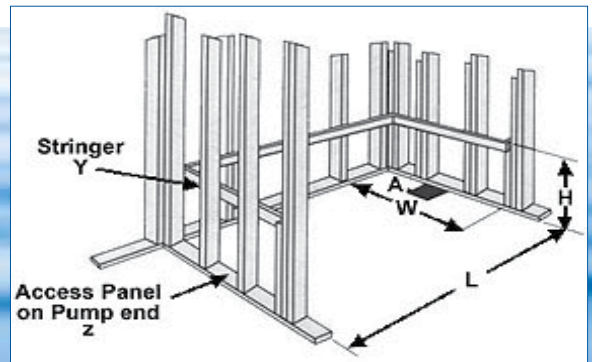

Island Drop-In				3 Wall Installation		
Model	(L)ength	(W)idth	(H)eigth Finish	(L)ength	(W)idth	(H)eigth Ledger Moldel Flange
6036	57¾"	33¾"	18"	60"	36"	19½"
6636	63¾"	33¾"	18½"	66"	36"	19¾"
7236	69¾"	33¾"	18"	70"	36"	19½"