

LINDSEY 6030

STUDIO COLLECTION

H | S

PVC SYSTEMS INCLUDE:

- 6 Fully directional adjustable PVC jets
- Anti-vortex safety suction
- Color matched system trim
- Rigid PVC piping
- Self draining pump and system
- Air switch control
- 1.25 HP single speed pump
- Requires 120 V 15 Amp Dedicated GFCI



OPTIONS: [\(MORE INFORMATION AVAILABLE ON OUR WEBSITE\)](#)

- Custom jet and pump locations
- Integral waste and overflow (round)
- In-line heater
- Hydro Coat
- Hydro Express quick ship
- Cable Waste and Overflow
- Hydrozone

STANDARD ELECTRICAL REQUIREMENTS:

- Whirlpool System | One 20 Amp Dedicated Circuit
- Thermal Air System | One 15 Amp Dedicated Circuit
- Inline Heater (600 or 1500 Watts) | One 15 Amp Dedicated Circuit

All electrical components come standard at 115 volts

All electrical circuits must be GFCI protected



LINDSEY 6030

STUDIO COLLECTION

H | S

As SHOWN:

Whirlpool option with standard jet location

FEATURES SHOWN:

- Jets
- Overflow location

ALSO AVAILABLE:

- Soaking tub only
- Whirlpool
- Thermal Air

WATER CAPACITY:

60 Gallons

WEIGHT:

65 - 85 Pounds

DROP-IN INSTALLATION DIMENSIONS:

- (L)ength- 58"
- (W)idth- 28"
- (H)eight- 19.25"

3-WALL INSTALLATION DIMENSIONS:

- (L)ength- 60"
- (W)idth- 30"
- Ledger-19.75"



ACRYLIC TUB

- Extra thick reinforced fiberglass
- Pre-wired pump on pump platform (standard pump location only)
- Integral E-Z level platform facilitates installation
- Tub must be set in mortar base
- When adding linear option, p-trap is located directly below waste

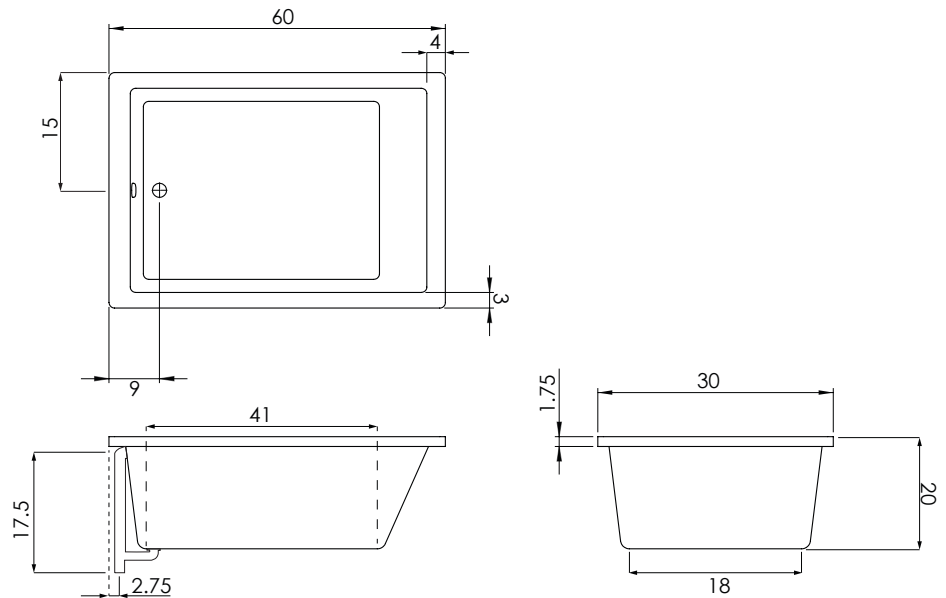

CODES AND COMPLIANCES

Massachusetts code File no: P1-0614-491



HYDRO SYSTEMS
Family Owned And Operated Since 1978

29132 Avenue Paine, Valencia, CA, 91355
661.775.0686 | hydrosystem.com



Page 2 of 2 **MADE IN AMERICA**

All specifications and options subject to change without notice please contact a Hydro Systems representative for more information. Certain options or altering the pump/blower location may cause the pump/blower to extend beyond the tub decking. For cutout dimensions wait for unit to arrive. All specifications subject to change without notice.